

**ERRATA CORRIGE:**

**MISURE D'INSTALLAZIONE DELLA STAFFA SULL'ANTA MOBILE - MOTORIZZAZIONI BL ASY**

**Errata corrige: BL ASY Pag. 4**

Fig. E

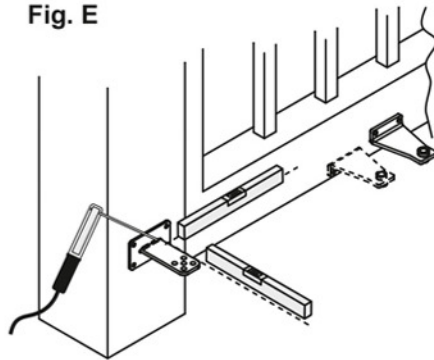

Fig. E1

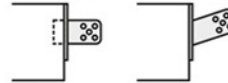

Fig. E3

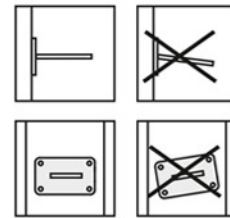

Fig. E2

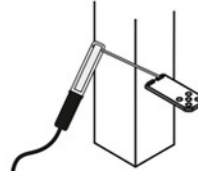

Fig. F

(mm)

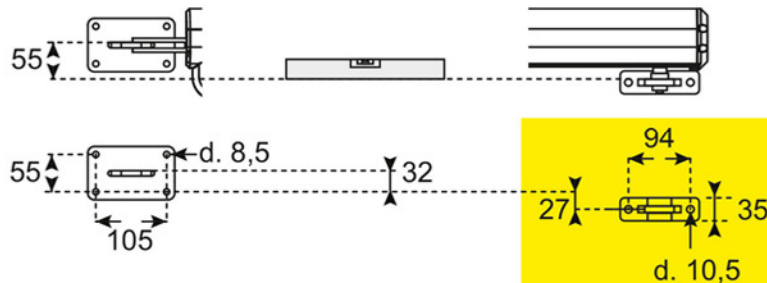

Fig. G

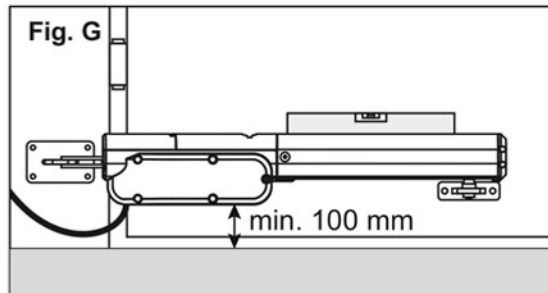
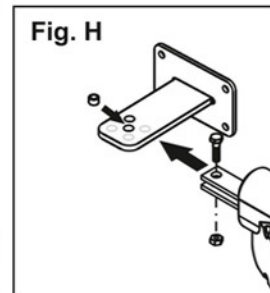

Fig. H



4